

ADVANCED HIGH CEILING

Tetriss Series - Standard



High lumen modular luminaire with lumen output 5440 – 52220lm for replacement of up to 1500W Metal Halide. Additional features include IP65, outdoor/natorium rating, and uplight option.

- Outdoor/Natorium Rating
(Please refer to Outdoor/Natorium Version spec sheet)

Special coating, sealant, and wiring is applied for long term operation in harsh environments.

Quantity		Type	
Project		Note	

Electrical System

- 6700lm (70W)
- 26200lm (280W)
- 39640lm (420W)
- 52220lm (560W)
- Power Input: Universal (120-277V)
- Operating Temperature: -40°F~122°F
- Surge Protection: 10KV
- Remote Emergency Pack: Bodine BSL20HV

LED Technology

- 3000K, 4000K , 5000K
- 75 CRI, 85 CRI
- Beam Angle: 15°, 25°, 40°, 60°
- Rated Life > 60,000 hours (L70)

Advanced Dimming

(Proprietary VX Driver is incorporated to all dimming options for video flicker-free lighting)

- Standard 0-10V: dims to 10%

Housing

- Material: Aluminum Heat Sink, Tempered Glass
- Weight: 280W / 26.46lbs, 420W / 37.48lbs, 560W / 47.30lbs

Mounting

- Standard Bracket
- Floodlight
- Uplight Mounting Bracket (3/4" stem by others)
- (AC/Dimming cable length: Standard / 6ft , Uplight / 15ft)

Warranty

- 5 years limited warranty.

Listing

- UL Damp Location Listed
- DLC Listed
- CE



Not all Tetriss Series are DLC qualified. For all qualified products. Please visit: www.designlights.org/qpl

Tetriss Series - Standard



How To Specify:

Ordering Example: TS-420-507-UNV-STV-25-BLK-STD

6-7 weeks lead time on over 75% of specifications.

Model	Wattage	CCT / CRI	Voltage	Dimming
TS				
TS Tetriss Series	70 70W 280 280W 420 420W 560 560W	308 3000K / CRI85 408 4000K / CRI85 507 5000K / CRI75	UNV 120-277V HVT 347-480V	STV Standard 0-10V dims to 10%

Beam Angle	Finish	Mounting	Accessories
15 15° 25 25° 40 40° 60 60°	BLK Black WHT White	STD Standard Bracket FLD ¹ Floodlight Bracket UPLIGHT ^{1,2} Uplight Bracket	GSB ¹ Glare Shield Baffle GSV ² Glare Shield Visor EMP Remote Emergency Pack SLP Slipfitter
		¹ Option is not compatible with 70W . ² Stem length is required when placing order.	¹ Please factor in change in lumen output of -40%. ² Please factor in change in lumen output of -25%

DesignLights Consortium™ Qualified Luminaires:

DLC QPL Model Number : TS-560-40K

Not all product variations listed on this page are DLC qualified.

To ensure that a specific model is qualified, visit www.designlights.org/search.

Tetriss Series - Standard



Delivered Lumens*

*Tolerance ±8%

Wattage \ CCT	70W	280W	420W	560W
	Beam Angle: 20°			
5000K	6700 lm	26200 lm	39640 lm	52220 lm
4000K	5850 lm	23400 lm	35000 lm	46120 lm
3000K	5440 lm	21580 lm	32500 lm	42700 lm

Current Consumption

Wattage \ Volt	120V	277V
70W	0.76A	0.33A
280W	3.02A	1.31A
420W	4.53A	1.96A
560W	6.04A	2.62A

Dimensions

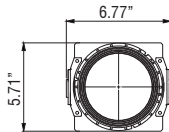

70W / 1 Modules

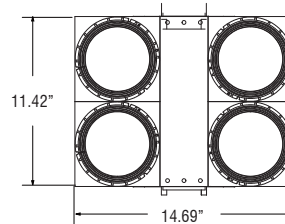

280W / 4 Modules

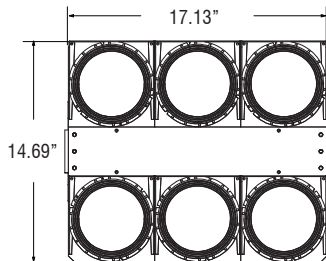

420W / 6 Modules

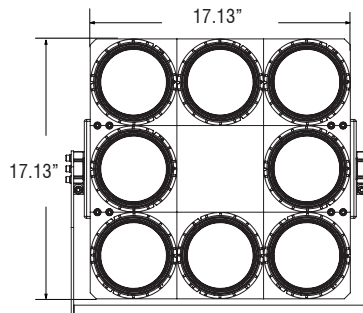

560W / 8 Modules

Mounting Options

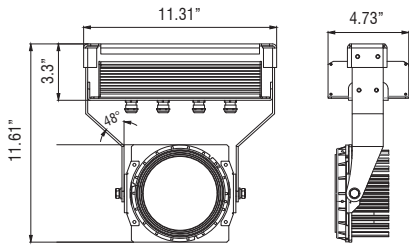

Standard Bracket / 1 Modules

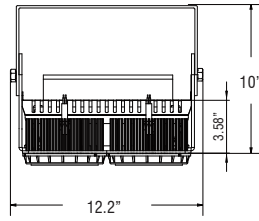

Standard Bracket / 4 Modules

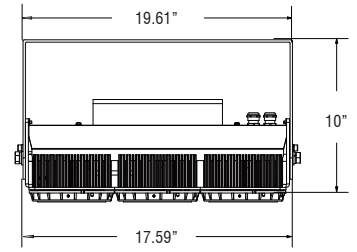

Standard Bracket / 6&8 Modules

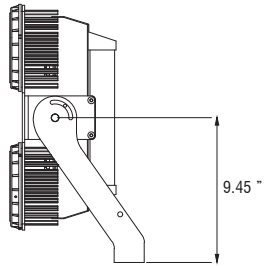

Floodlight Bracket / 4&6 Modules

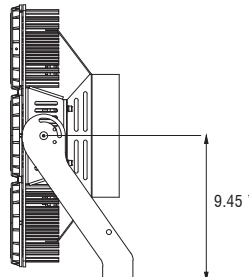

Floodlight Bracket / 8 Modules

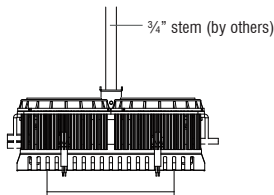

Uplight / 4 Modules

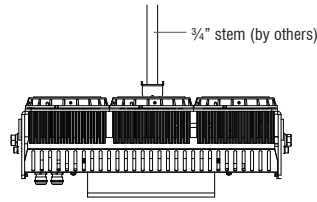

Uplight / 6&8 Modules

Accessory

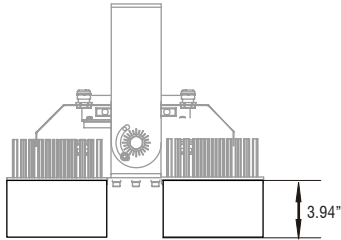

Glare Shield Baffle

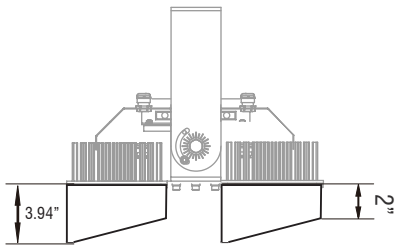
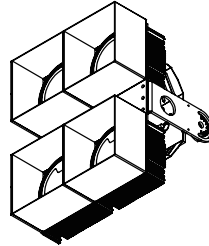

Glare Shield Visor

